

URBANA

LUXURY FIREPLACES

U30 - U50 - U70

USER MANUAL

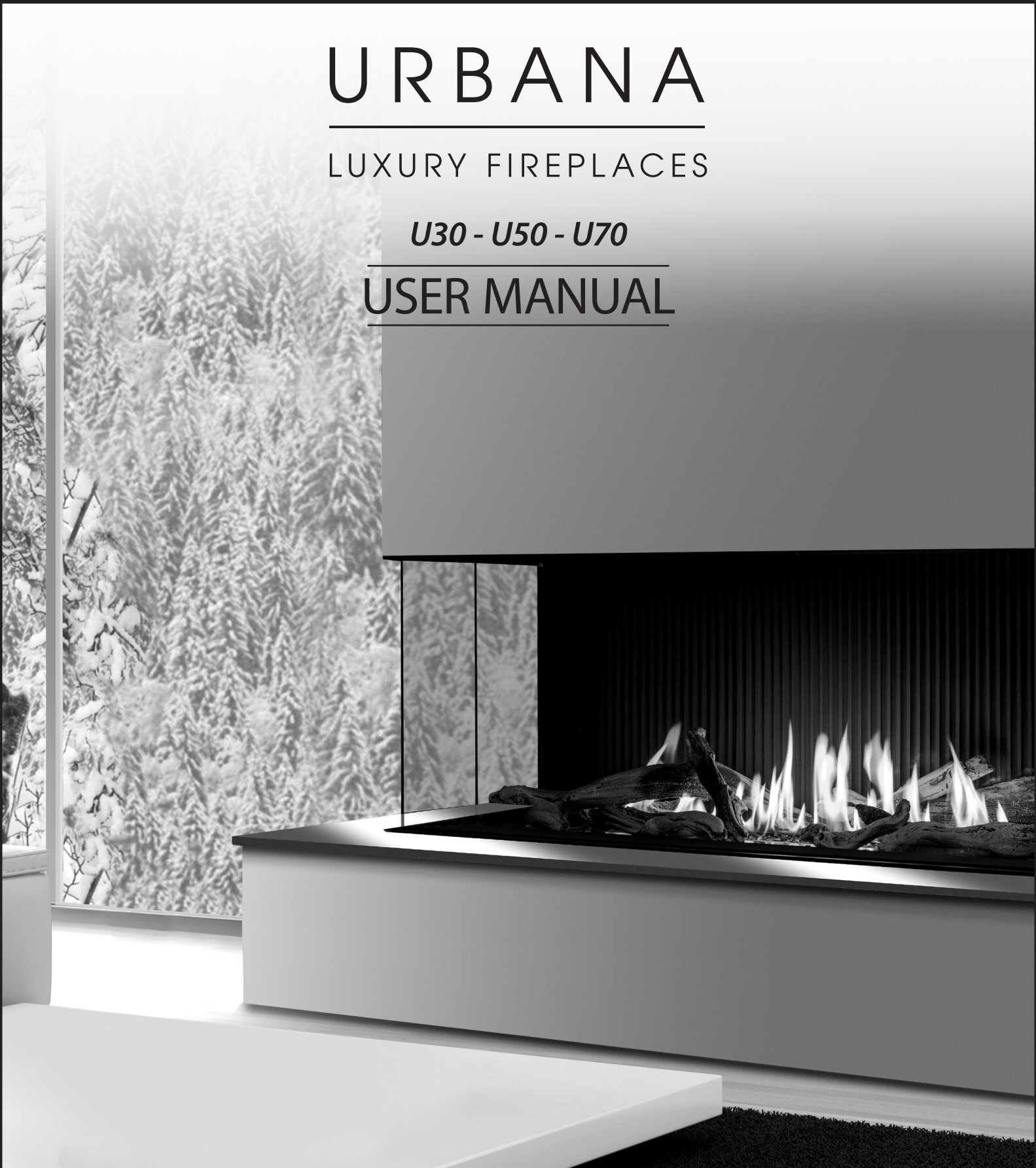

WARNING: If the information in this manual is not followed exactly, a fire or explosion may result causing property damage, personal injury or loss of life. Installation and service must be performed by a qualified installer, service agency or the gas supplier.



Intertek
C#4001609

CERTIFIED TO: ANSI Z21.88 / CSA 2.33 VENTED GAS FIREPLACE HEATERS
CSA 2.17 GAS FIRED APPLIANCES FOR HIGH ALTITUDES

Retain this manual for future reference.



WARNING:

FIRE OR EXPLOSION HAZARD

Failure to follow safety warnings exactly could result in serious injury, death, or property damage.

- **Do not store or use gasoline or other flammable vapours and liquids in the vicinity of this or any other appliance.**

- **WHAT TO DO IF YOU SMELL GAS**
 - **Do not try to light any appliance.**
 - **Do not touch any electrical switch; do not use any phone in your building.**
 - **Leave the building immediately.**
 - **Immediately call your gas supplier from a neighbor's phone. Follow the gas supplier's instructions.**
 - **If you cannot reach your gas supplier, call the fire department.**

- **Installation and service must be performed by a qualified installer, service agency or the gas supplier.**

This appliance is only for use with the type of gas indicated on the rating plate. This appliance is not convertible for use with other gases.

Massachusetts installations (Warning): This product must be installed by a licensed plumber or gas fitter when installed within the Commonwealth of Massachusetts. Other Massachusetts code requirements: Flexible connector must not be longer than 36in., a shut off valve must be installed; only direct vent sealed combustion products are approved for bedrooms/bathrooms. A carbon monoxide detector is required in all rooms containing gas fired direct vent appliances. The fireplace damper must be removed or welded in the open position prior to installation of a fireplace insert.

FOR SAFE INSTALLATION AND OPERATION OF YOUR "URBANA" HEATER, PLEASE CAREFULLY READ THE FOLLOWING INFORMATION:

- All Urbana gas-fired appliances must be installed in accordance with their instructions. Carefully read all the instructions in this manual first. Consult the building authority having jurisdiction to determine the need for a permit prior to commencing the installation.
- **WARNING:** Failure to follow these instructions could cause a malfunction of the fireplace, which could result in death, serious bodily injury, and/or property damage.
- Failure to follow these instructions may also void your fire insurance and/or warranty.
- Installation and repair should be done by a qualified service person. The appliance should be inspected before the first use and, at least, annually by a qualified service person. More frequent cleaning may be required due to excessive lint from carpeting, bedding material, etc. It is imperative the control compartments, burners and circulating air passageways of the appliance be kept clean.
- Due to high temperatures, the appliance should be located out of high traffic areas and away from furniture and draperies.
- Children and adults should be alerted to the hazards of high surface temperatures and should stay away to avoid burn or clothing ignition.
- Young children should be carefully supervised when in the same room as the appliance. Toddlers, young children and others may be susceptible to accidental contact burns. A physical barrier is required if there is a risk for individuals in the house. To restrict access to a fireplace or stove install an adjustable safety gate to keep toddlers, young children and other at risk individuals out of the room and away from hot surfaces. Any safety screen, guard, or barrier removed for servicing an appliance must be replaced prior to operating the appliance.
- Clothing or other flammable materials should not be placed on or near the appliance.
- A barrier designed to reduce the risk of burns from the hot viewing glass is provided with this appliance and shall be installed for the protection of children and other at-risk individuals. If the barrier becomes damaged, the barrier shall be replaced with the manufacturer's barrier for this appliance.
- Installation and service must be performed by a qualified installer, service agency or gas supplier.
- This installation must conform to local codes or, in the absence of local codes, with the National Fuel Gas Code, ANSI Z223.1/NFPA 54, or the Natural Gas and Propane Installation Code, CSA B149.1.
- To prevent injury, do not allow anyone who is unfamiliar with the stove to operate it.
- To prevent injury, if the pilot or pilot and burners have gone out on their own, wait 5 minutes to air out before attempting to re-light the stove.
- Always keep the area around these appliances clear of combustible material, gasoline and other flammable liquids and vapours.
- These appliances should not be used as a drying rack for clothing or for hanging Christmas stockings/decorations.
- Due to the paint curing on the stove, a faint odor and slight smoking will likely be noticed when the stove is first used. Open a window until the smoking stops.
- Always connect this gas stove to a vent system and vent to the outside of the building envelope. Never vent to another room or inside the building. Make sure the specified vent pipe is used, properly sized and of adequate height to provide sufficient draft. Inspect the venting system annually for blockage and signs of deterioration.
- **WARNING:** Failure to position the parts in accordance with the diagrams in this booklet, or failure to use only parts specifically approved with this appliance, may result in property damage or personal injury.
- **WARNING:** Do not operate with the glass front removed, cracked or broken. Replacement of the glass should be done by a licensed or qualified service person.
- Never use solid fuels such as wood, paper, cardboard, coal, or any flammable liquids, etc., in this appliance.
- Do not use this appliance if any part has been under water. Immediately call a qualified service technician to inspect the appliance and to replace any part of the control system or any gas control which has been under water.
- Do not abuse the glass by striking it or slamming the door shut. If the Urbana unit is pulled out of its installation, and the vent-air intake system is disconnected for any reason, ensure that the vent-air intake pipes are reconnected and re-sealed in accordance to the instructions noted in Initial Installation - Direct Vent

FOR YOUR SAFETY

DANGER



**HOT GLASS WILL
CAUSE BURNS**

**DO NOT TOUCH GLASS
UNTIL COOLED.**

**NEVER ALLOW CHILDREN
TO TOUCH GLASS.**

A barrier designed to reduce the risk of burns from the hot viewing glass is provided with this appliance and shall be installed for the protection of children and other at-risk individuals.

DIRECT VENT ONLY: This type is identified by the suffix DV. This appliance draws all of its air for combustion from outside the dwelling, through a specially designed vent pipe system.

This appliance has been tested and approved for installations from 0 feet to 4500 feet (1372 m) above sea level.

In the USA: The appliance may be installed at higher altitudes. Please refer to your American Gas Association guidelines which state: the sea level rated input of Gas Designed Appliances installed at elevations above 2000 (610 m) feet is to be reduced 4% for each 1000 feet (305 m) above sea level. Refer also to local authorities or codes which have jurisdiction in your area regarding the de-rate guidelines.

In Canada: When the appliance is installed at elevations above 4500 feet (1372 m), the certified high altitude rating shall be reduced at the rate of 4% for each additional 1000 feet (305 m).

- This appliance has been tested by INTERTEK and found to comply with the established VENTED GAS FIREPLACE HEATER standards in CANADA and the USA as follows:

VENTED GAS FIREPLACE HEATER (NATURAL GAS, PROPANE GAS)

CERTIFIED TO: ANSI Z21.88 / CSA 2.33 VENTED GAS FIREPLACE HEATERS

CSA 2.17 GAS FIRED APPLIANCES FOR HIGH ALTITUDES

This Urbana Fireplace:

- Has been certified for use with either natural gas or propane (see rating label).
- Is not for use with solid fuels.
- Is approved for a bedroom or bed sitting room. (**IN CANADA:** must be installed with a listed wall thermostat. **IN USA:** see current ANSI Z223.1 for installation instructions.)
- Must be installed in accordance with local codes. If none exist, use current installation code CAN/CGA B149.1 in Canada or ANSI Z223.1/NFPA 54 in the USA.
- Must be properly connected to an approved venting system and not connected to a chimney flue serving a separate solid-fuel burning appliance.

IMPORTANT NOTICE (Regarding first fire up): When the unit is turned on for the first time, it should be turned onto high for the first 4 hours. This will cure the paint, logs, gasket material and other products used in the manufacturing process. It is advisable to open a window or door, as the unit will start to smoke and can irritate some people. After the unit has gone through the first burn, turn the unit off including the pilot, let the unit get cold then remove the glass door and clean it with a good gas fireplace glass cleaner, available at your local Urbana dealer.

**NATIONAL
FIREPLACE
INSTITUTE**



CERTIFIED

www.nficertified.org

We recommend that our gas hearth products be installed and serviced by professionals who are certified in the U.S. by the National Fireplace Institute® (NFI) as NFI Gas Specialists.

CONTENTS

Safety Precautions.....4

Operating Instructions.....6

Remote Control 6
Remote Control Icons 6
Syncing Your Remote to the Fireplace 7
Temperature Unit Setting..... 7
Remote Control Key lock..... 7
Low Battery Power Detection..... 7
Pilot Light Modes 8
Changing Pilot Light Mode 8
Turning On Your Fireplace 8
Smart Thermostat 8
Room Thermostat (Remote Operation)..... 9
Flame Height Control 9
Top Lights 10
AUX Inputs - LED Lighting (Optional)..... 10

Optional LED Lights..... 11

LED Light Setup 11
How To Use MyLED Pro App 13

Parts List..... 14

Troubleshooting..... 17

Installation Reference Guide 18

Warranty Information..... 19

CAUTION!

Property Damage Hazard. Excessive heat can cause property damage. The appliance can stay lit for many hours. Turn off the appliance if it is not going to be attended to .

ATTENTION!

Turn "off" the main gas supply of the appliance during installation or maintenance of the IFC.

WARNING!

Fire Hazard. Can cause severe injury or death. The Transmitter causes ignition of the appliance. The appliance can turn on suddenly. Keep away from the appliance burner when operating the remote system.

Remote Control Technical Data

Proflame 2 is a modular remote control system that directs the functions of the fireplace. The Proflame 2 remote transmitter is configured to control the on and off function of the main burner. The systems also allows your to modulate the thermostat, flame level, and accent light features.

System Description:

1. Proflame 2 Transmitter
2. Integrated Fireplace Controller (IFC) and a wiring harness to connect to the gas valve and stepper motor

Technical Data:

Transmitter (Remote Control):

- Supply voltage: 4.5 V (three 1.5 V AAA batteries)
- Radio frequency: 315 MHz

Integrated Fireplace Controller (IFC):

- Supply voltage: AC IN - 120 V / 60 Hz
- Spark voltage / frequency: >10kV / 1Hz
- Top Lights: 120 V / 60 Hz / 850mA [total]
- AUX LED Light: 120 V / 60Hz / 200mA

Remote Control

The Proflame 2 uses a streamline design, remote control to allow the user to interact with the system. The simple button layout and LCD display offers a user friendly experience. The MODE key is used to cycle through different features and the THERMOSTAT key is used to manage thermostatic functions. The transmitter is powered by three (3) AAA type batteries.

Note: Other remote transmitters may interfere with the system if you have another within the vicinity.

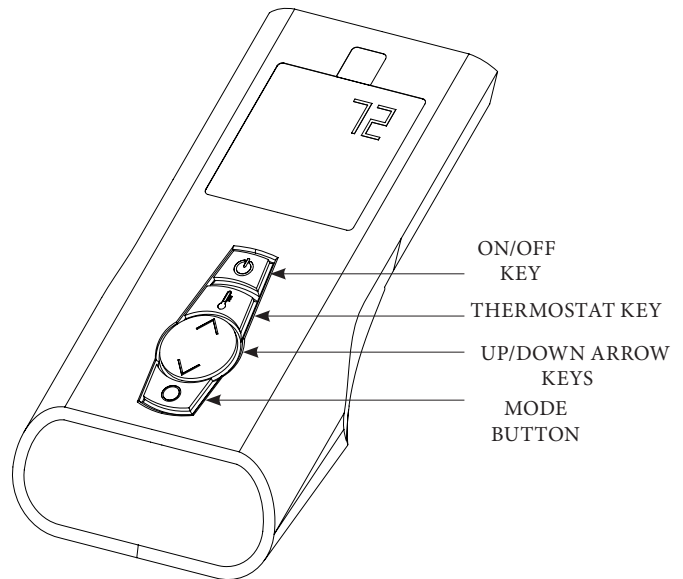

Remote Control Icons

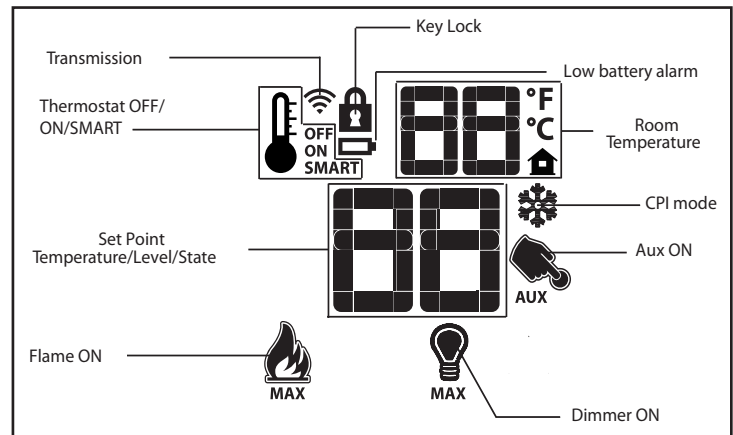

Syncing Your Remote to the Fireplace

The remote should be synced to your fireplace by your installer during installation. You will also need to re-sync your remote after changing the batteries

1. Locate the tool you received with your fireplace.
2. Each unit in the U-Series has a hidden switch

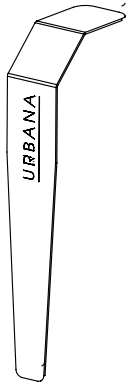

panel located on the right hand side of the front glass. Using a flashlight, locate the switch panel.

3. Slip the tool in between the front glass and the cabinet of the fireplace.

4. Use the Urbana tool to press on the middle switch; you will hear a series of 3 beeps.

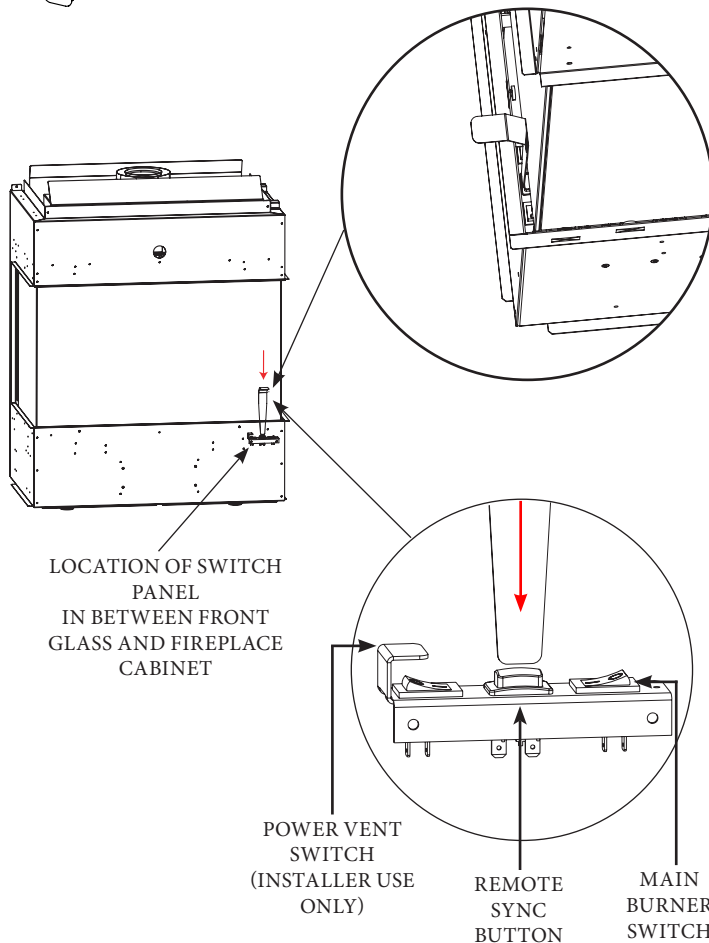

5. On hearing the 3 beeps, press the on/off key on your remote; you will hear 3 more beeps to acknowledge a successful remote syncing.

6. Press the on/off button again to turn off the remote. The remote is now ready to use.

Temperature Unit Setting

Your remote can be set to either read °C or °F. To set your preferred unit:

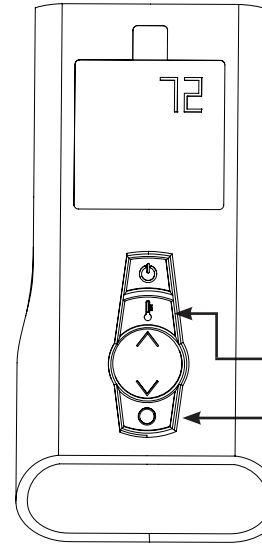

Press the Thermostat key and the Mode key simultaneously while the system is OFF.

The remote transmitter will indicate which temperature scale is being displayed (°C or °F). Repeat this sequence to change between Centigrade and Fahrenheit

THERMOSTAT KEY
MODE KEY

Remote Control Key lock



This function will lock the remote keys to avoid unsupervised operation.

To activate this function, press the MODE and UP keys at the same time and the a lock icon will appear.

To de-activate this function, press the MODE and UP Keys at the same time.



KEY LOCK

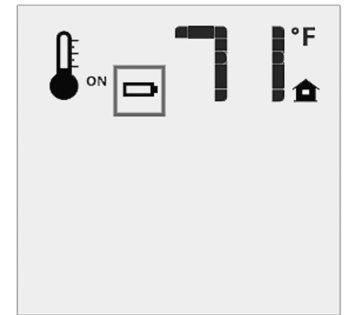

BATTERY LOW INDICATOR

Low Battery Power Detection



The life span of the remote control batteries depends on various factors. Quality of the batteries used, the number of appliance ignitions, the number of thermostat set point changes to the room, etc.

When the Transmitter batteries are low, a battery icon will appear on the LCD display of the Transmitter.

Pilot Light Modes

Your fireplace has a pilot light which ignites the main burner.

The way in which your pilot light functions can be adjusted to your preference. The two different modes and their uses are listed below:

IPI - Intermittent Pilot Ignition

IPI mode only turns on when required. The pilot light remains off until you press the power key on the remote. After a few seconds, the pilot light will ignite and remain lit during the your operation of the fireplace.

This mode will use less gas, as it only uses gas when the fireplace is on.

IPI mode is often used at the end of winter when you are no longer using the fireplace regularly.

CPI - Continuous Pilot Mode

CPI mode keeps the pilot light ignited for 7 days. Keeping the pilot ignited, allows the firebox to remain warm. This helps the fireplace establish a draft which can be useful for days with high wind and extreme cold. Keeping the fireplace warm and thereby dry; this also helps to reduce condensation build up on the glass.

Changing Pilot Light Mode



With the fireplace turned off, press the MODE key. The screen will now show the current pilot mode selected use the UP and DOWN arrow keys to cycle between IPI and CPI modes.

Once the selection has been made, the fireplace will beep to acknowledge the changing of the mode.

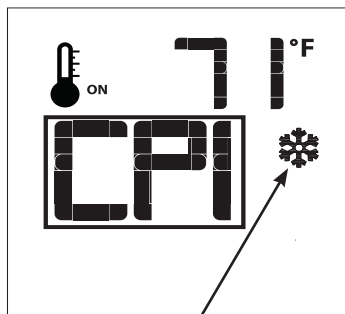
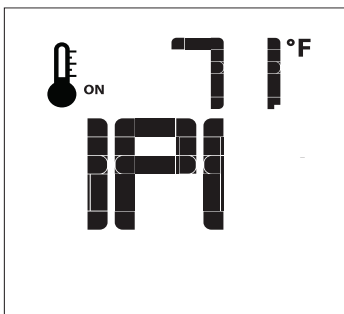

ICON CONFIRM CPI MODE SELECTION

Turning On Your Fireplace



Press the ON/OFF Key on the remote; the LCD display will show the room temperature.

A single "beep" from the fireplace confirms reception of the command and both the pilot light (if the unit is not set to continuous pilot) and main burner will turn off.

Note - if no beep is heard from the fireplace move closer to the unit and try again.

Smart Thermostat



The Smart Thermostat function adjusts the flame height in accordance to the difference between the set point temperature and the actual room temperatures. As the room temperature gets closer to the set point, the Smart Function will modulate the flame down.

Press the Thermostat Key until the word "SMART" appears to the right of the temperature bulb graphic.

To adjust the set temperature, press the UP or DOWN arrow keys until the desired set temperature is displayed on the LCD screen of the remote.

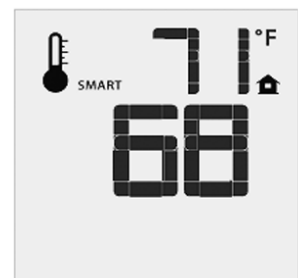

Room Thermostat (Remote Operation)



The remote can operate as a room thermostat. The thermostat can be set to a desired temperature to control the comfort level in a room.

To activate this function:

1. Press the Thermostat Key.
2. The LCD display on the remote will change to show that the room thermostat is "ON" and the set temperature is now displayed.
3. To adjust the set temperature, press the UP or DOWN arrow keys until the desired set temperature is displayed on the LCD screen of the remote.

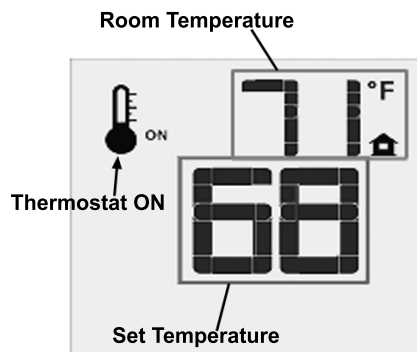

Flame Height Control



Your fireplace has 6 flame height settings. To control the height of the flame:

1. Turn on your fireplace; the flame always starts on the maximum setting "Hi"
2. With your fireplace fully ignited, press the DOWN arrow key to set the desired height of your flame.

When lowering the flame height, you can turn off the fireplace with this method. The remote will read OFF when you have reached the lowest setting on the remote.

When increasing the flame height, the remote will read "Hi" when the maximum flame height is reached.



Flame Off

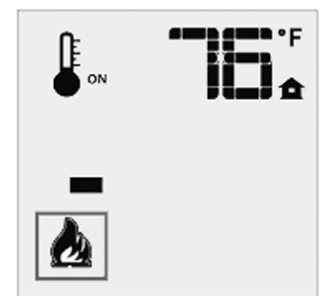

Flame Level 1

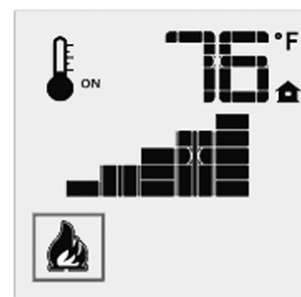

Flame Level 5

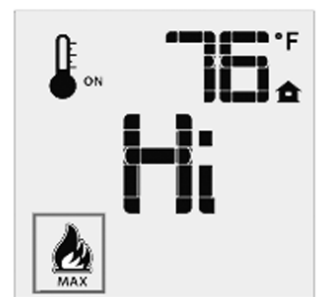

Maximum Flame Level

Top Lights



Your fireplace comes with top lights that illuminate the inside of the firebox. (All Urbana Series models come with top lights as a standard.)

To turn on your top light:

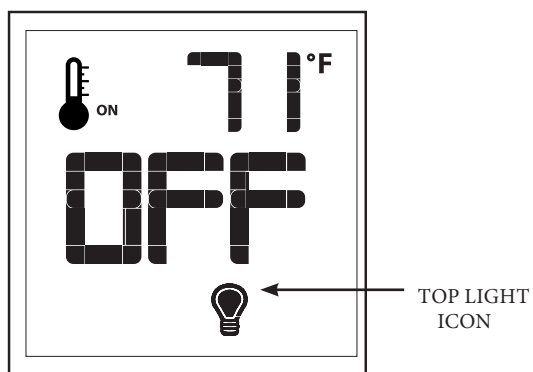

1. Turn on your fireplace.
2. Press the MODE key until the light bulb icon is visible.
3. You can control the brightness of your top light by pressing the UP and DOWN arrow keys to set your preferred brightness.

AUX Inputs - LED Lighting (Optional)



All models in the Urbana Series can be ordered with an optional LED kit. The LED kit will be controlled from your mobile device.

However, you will need to tell your fireplace that you have an LED kit installed.

To activate your LED light kit:

1. Turn on your fireplace.
2. Push the MODE key until the icon is displayed.
3. Use the UP arrow key to turn on the AUX input.

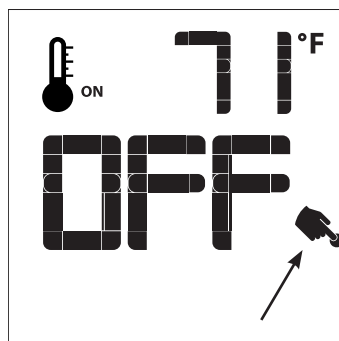

AUX ICON BEFORE ACTIVATING

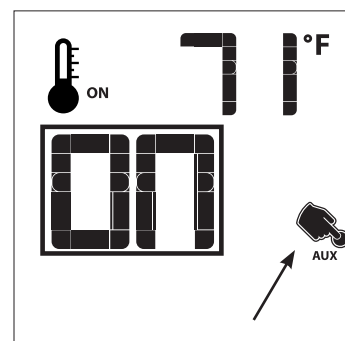

AUX ICON AFTER ACTIVATING

4. Your unit is now ready to receive commands from the lighting WIFI App.

LED Light Setup

The Urbana Series can be purchased with optional WIFI controlled LED lights. Our system comes with the addition of white LEDs to ensure our system has the largest variety and most natural choice of colours available.



1. Download the App MyLED Pro from either the Apple App store, or the Google Play store.

2. Using either the remote control or the Proflame App, turn on the AUX input.

3. Your LED lights should now cycle RED-GREEN-BLUE-WHITE continuously, this indicates pairing mode.

if your lights do not do this, contact your dealer for assistance.

4. Open the MyLED Pro App on your device.

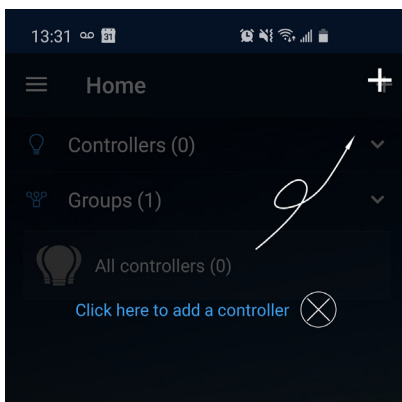

5. Tap "click here to add a controller."

6. Press the white + icon in the top right hand side of the screen.

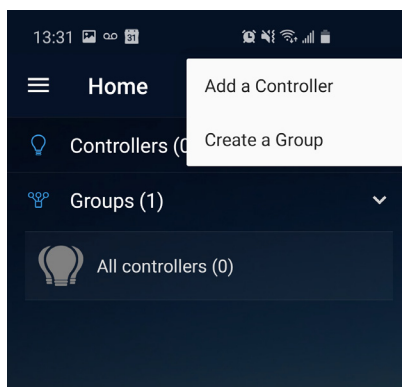

7. Tap "Add a Controller"

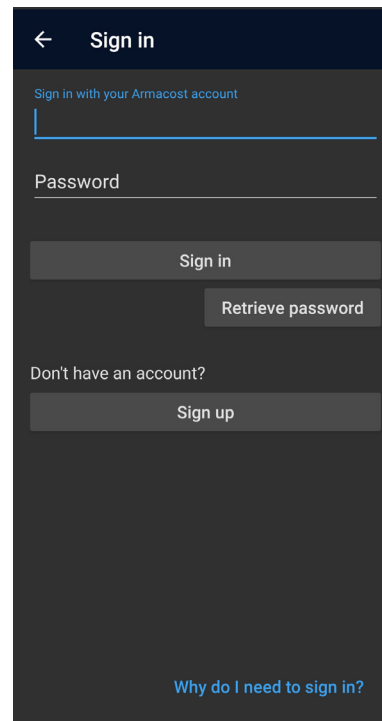

8. You will now need to either create a new account, or sign in to an existing MyLED Pro account. After creating an account, you will be prompted to allow the app to use the location feature on your device. This is necessary for the use of the LED system.

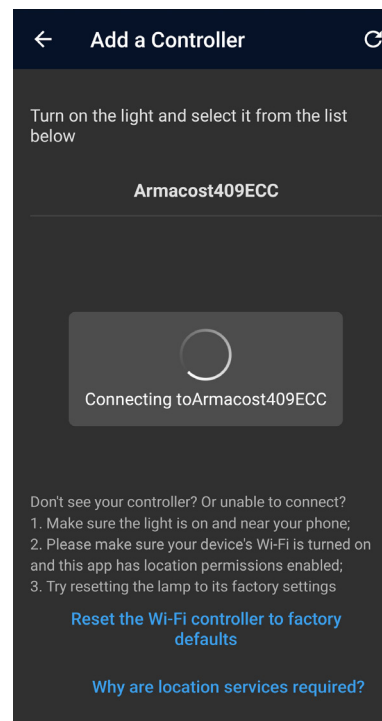

9. Tap on Armacost409ECC the app will now tell you it is connecting to **Armacost409ECC**

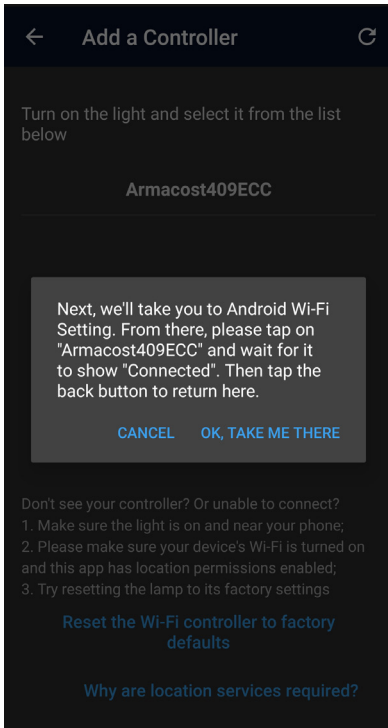

10. Navigate to your WIFI settings on your device to connect to the Armacost409ECC network, you will see this in your list of wifi networks. Or tap **OK, TAKE ME THERE**

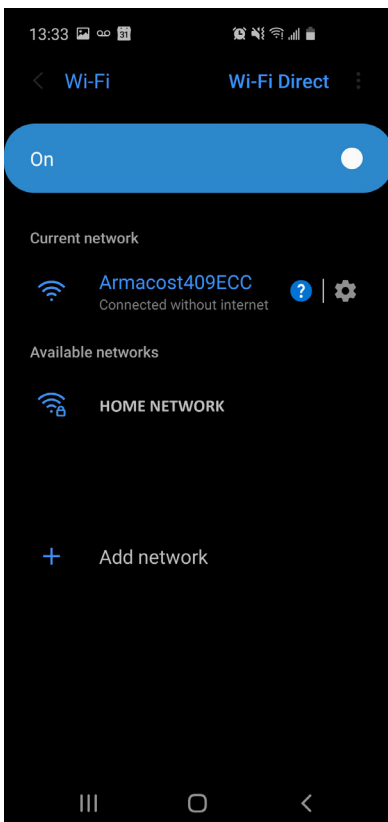

11. Tap on the **Armacost409ECC** available network. Your device will connect to this network. Your device may say that it has connected without internet access; this is normal.

After your device has connected to **Armacost409ECC** network, press the back button to navigate back to the Armacost Lighting APP

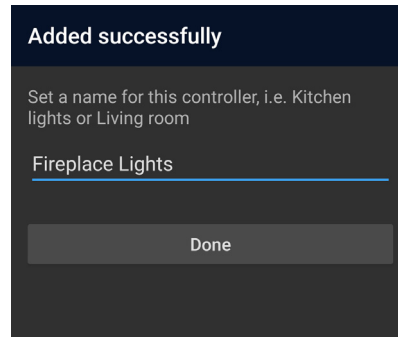

12. You will now be prompted to name your LED wifi controlled lights.

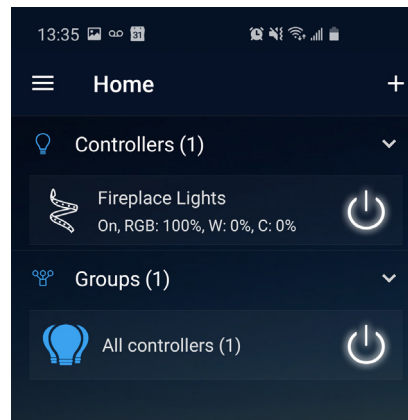

13. You will now be brought back to the app home screen where you will see the name you decided. Tap on the newly named device.

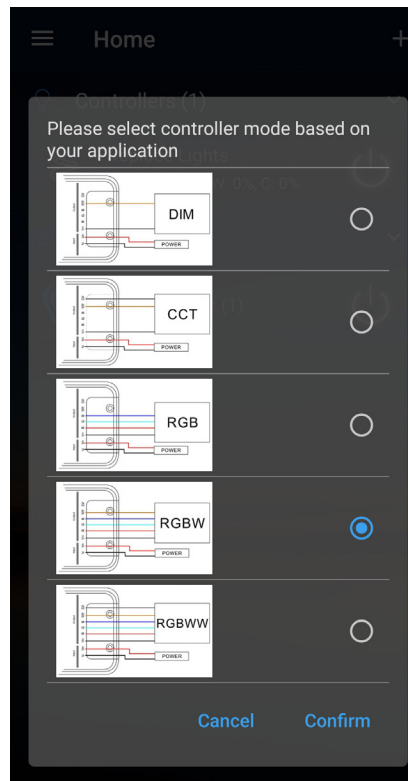

14. Your LED setup is comprised of RED GREEN BLUE and WHITE LEDs; you need to confirm with the app which setup your fireplace has installed.

Tap on the setup that says RGBW; after you have confirmed your selection, your fireplace LEDs are setup and ready to use.

How To Use MyLED Pro App

The MyLED Pro App has a multitude of different features and settings for your lights.

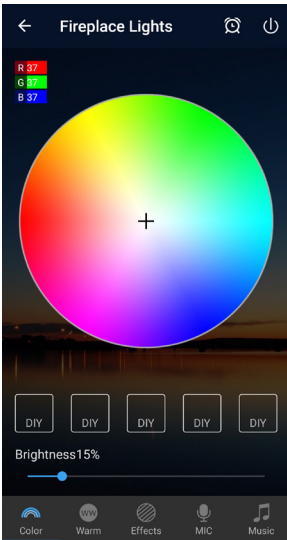

Colour Wheel

The colour wheel allows you to select your desired colour. Drag your finger across the wheel to set the colour.

The DIY buttons allow you to store your favourite colour for quick access.

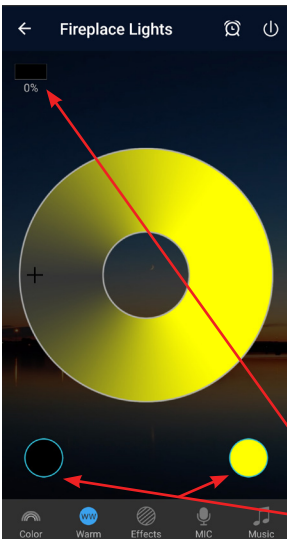

Warm Lights

Your fireplace is equipped with white LEDs; On the warm window you can determine the brightness and warmth of the white lights. Drag your finger across the wheel to select the warm white colour you desire.

(Turn the white light off when you require bright and vivid coloured LED lights)

White Light Brightness

White Light ON/OFF Toggle

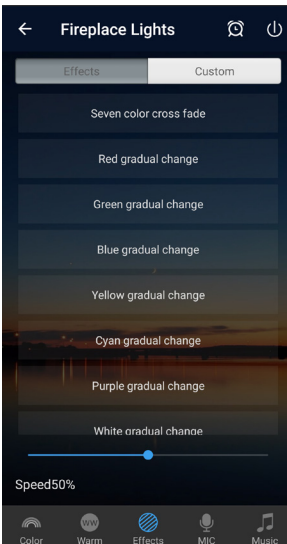

Effects

In this mode you can set predefined colour sweep routines. You can also determine the speed of the colour sweep and set your own routines using your favourite colours.

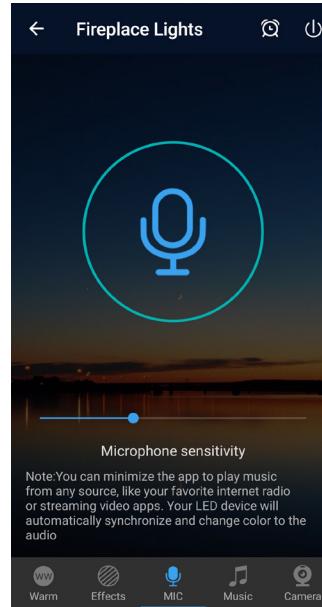

Microphone mode

In this mode your mobile device allows the lights to sync to the sound picked up by the microphone on your device.

Use this mode when you want lights to sync to music not stored on your mobile device i.e spotify/apple music/youtube.

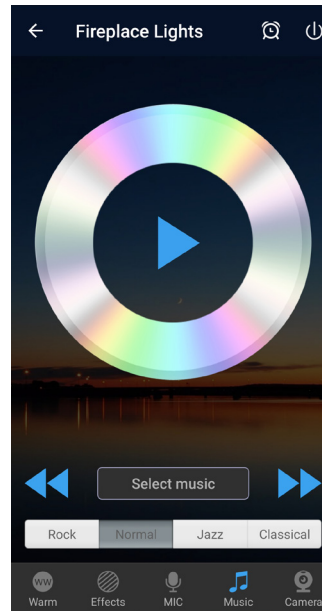

Music Mode

In this mode the app scans for stored music on your device and syncs the lights to the music.

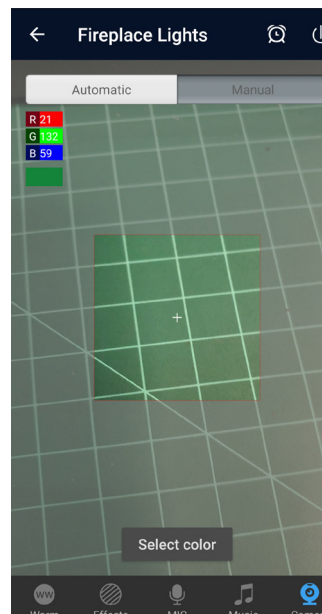

Camera Mode

In this mode the colour of the lights is selected from the camera on your device. The colour is chosen in the centre of the screen.

Automatic mode switches the colour of the lights depending on whatever is in the camera field of view.

Manual mode allows you to select the colours after pressing the **Select Colour** button.

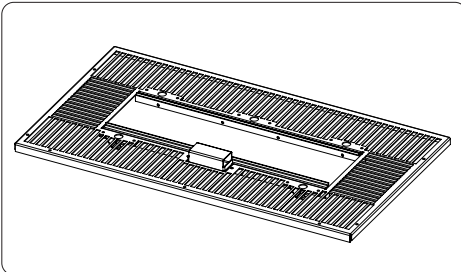
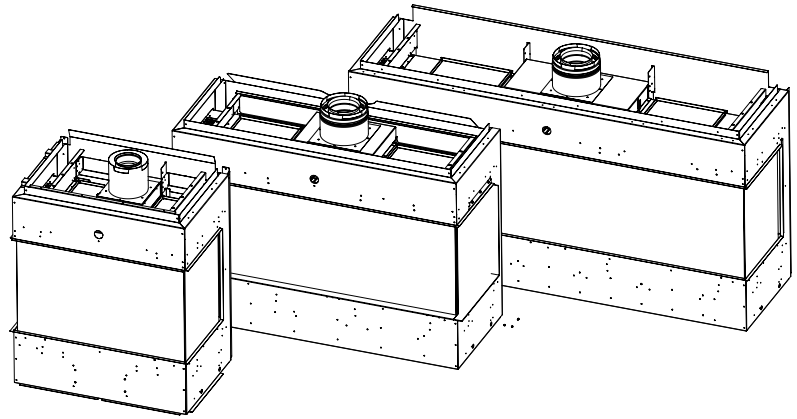

#50-3909 - U30 BURNER PLATFORM - LED

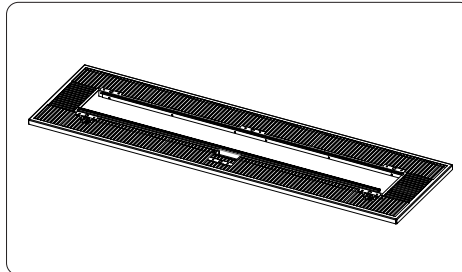

#50-3920 - U50 BURNER PLATFORM - LED

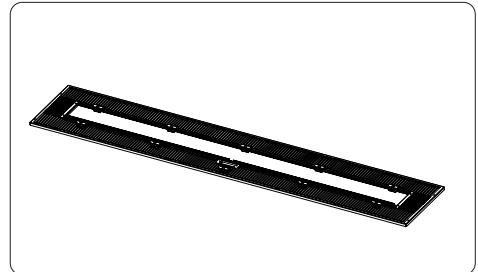

#50-3934 - U70 BURNER PLATFORM - LED

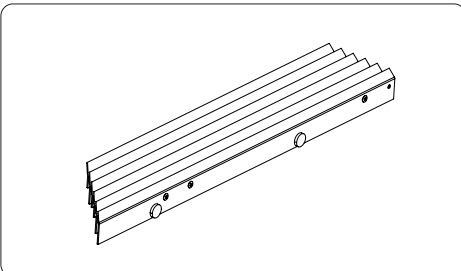

#50-3903 - RIGHT LOUVER ASSEMBLY
PART USED IN U30 U50 U70

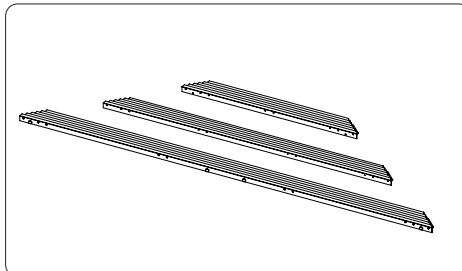

#50-3915 - U30 FRONT LOUVER ASSEMBLY
#50-3926 - U50 FRONT LOUVER ASSEMBLY
#50-3940 - U70 FRONT LOUVER ASSEMBLY

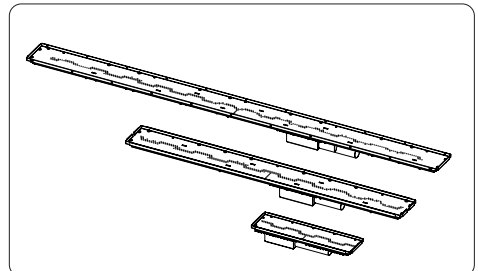

#50-3906 U30 BURNER (NG & LP)
#50-3917 U50 BURNER (NG) / #50-3918 (LP)
#50-3931 U70 BURNER (NG) / #50-3932 (LP)

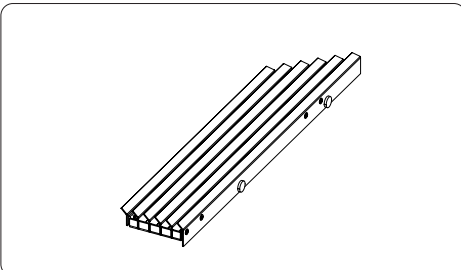

50-3902 - LEFT LOUVER ASSEMBLY
PART USED IN U30 U50 U70

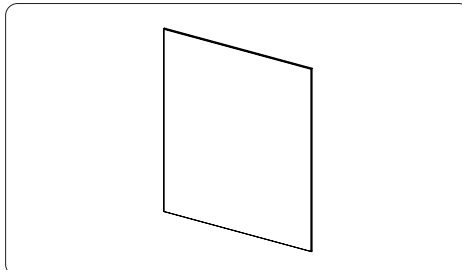

#50-3895 - URBANA OUTER SIDE GLASS
PART USED IN U30 U50 U70

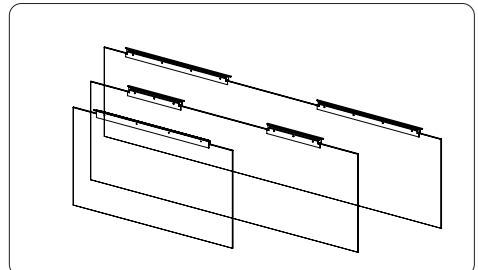

#50-3914 - U30 OUTER GLASS ASSEMBLY
#50-3925 - U50 OUTER GLASS ASSEMBLY
#50-3939 - U70 OUTER GLASS ASSEMBLY

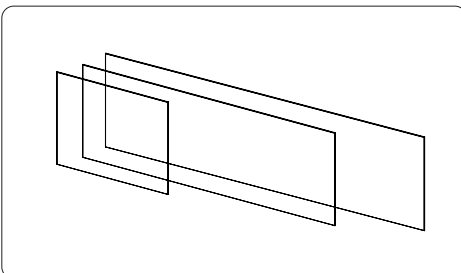

50-3913 - U30 INNER FRONT GLASS
50-3924 - U50 INNER FRONT GLASS
50-3938 - U70 INNER FRONT GLASS

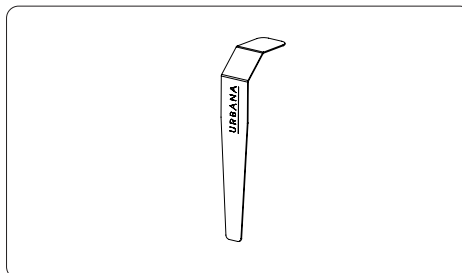

#50-3535 SWITCH TOOL
PART USED IN U30 U50 U70

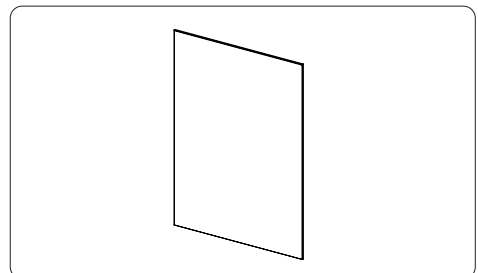

#50-3894 - URBANA INNER SIDE GLASS
PART USED IN U30 U50 U70

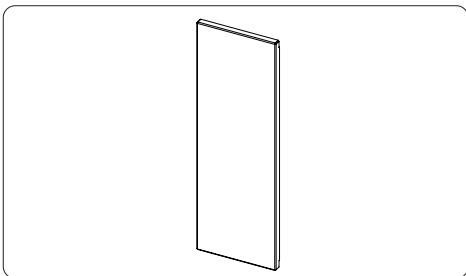

#50-3905 - STEEL SEGMENTED LINER (1 PCE.)
PART USED IN U30 U50 U70

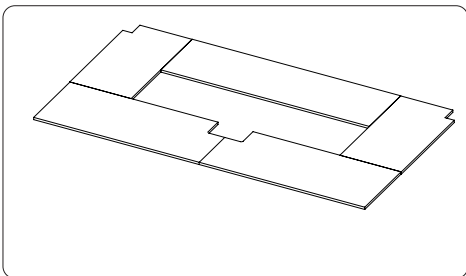

#50-3812 U30 INFINITY GLASS BEZEL - BLACK
#50-3820 U50 INFINITY GLASS BEZEL - BLACK
#50-3827 U70 INFINITY GLASS BEZEL - BLACK

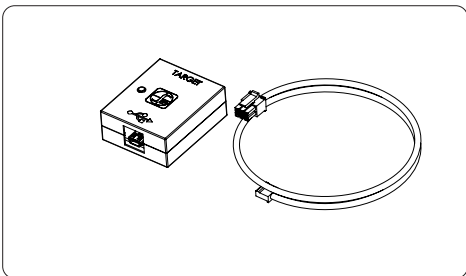

#50-3805 WIFI KIT
PART USED IN U30 U50 U70

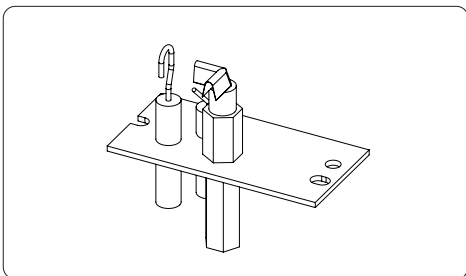

#50-4056 URBANA IPI PILOT ASSEMBLY
PART USED IN U30 U50 U70

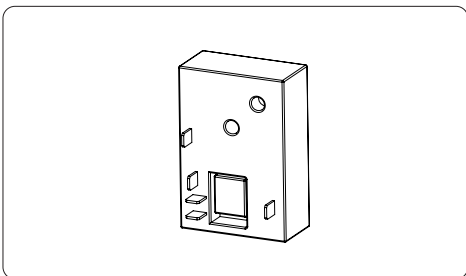

#50-3899 - URBANA FAN RELAY
PART USED IN U30 U50 U70

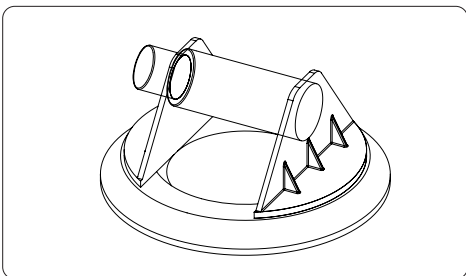

#50-3837 - SUCTION CUP HANDLE (1 PC)
PART USED IN U30 U50 U70

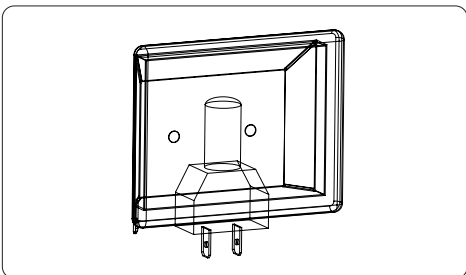

#50-3516 - TOP LIGHT ASSEMBLY
PART USED IN U30 U50 U70

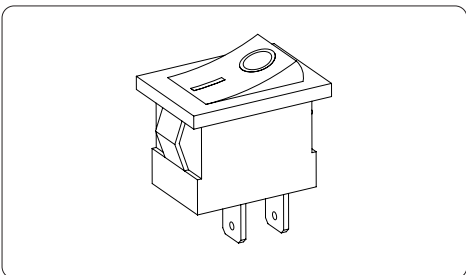

#50-3892 - URBANA ROCKER SWITCH
PART USED IN U30 U50 U70

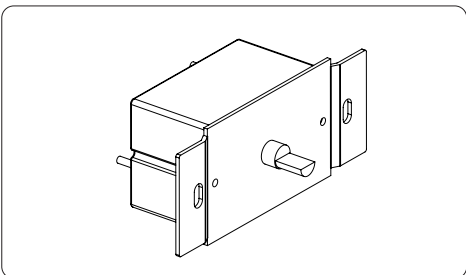

#50-3900 - URBANA FAN CONTROL
RHEOSTAT
PART USED IN U30 U50 U70

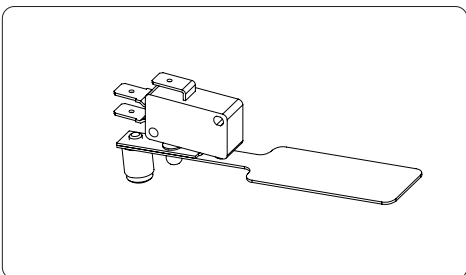

#50-3898 SAIL SWITCH ASSEMBLY
PART USED IN U30 U50 U70

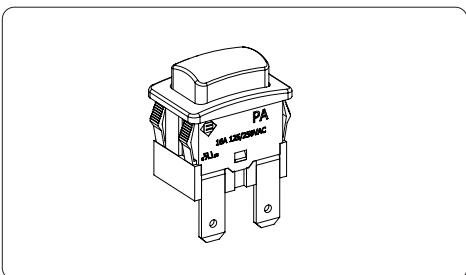

#50-3518 IFC RESET SWITCH
PART USED IN U30 U50 U70

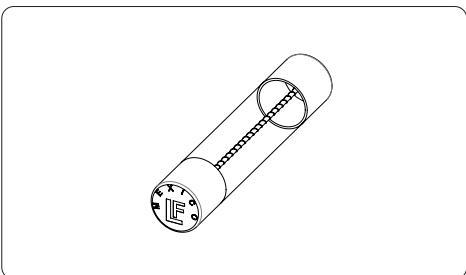

#50-2076 - 4 AMP FUSE
PART USED IN U30 U50 U70

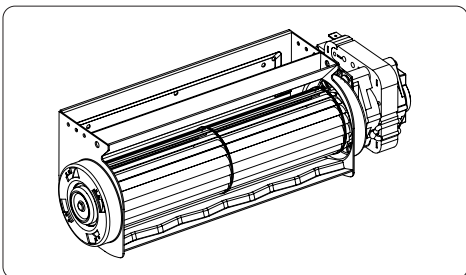

50-3901 - URBANA FAN
PART USED IN U30 U50 U70

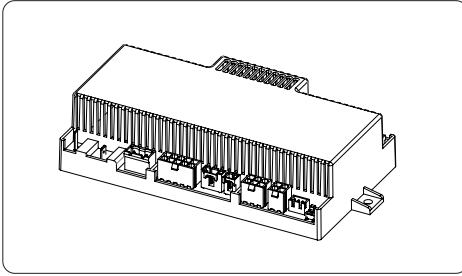

#50-3887 - PF2 WIFI READY IFC
PART USED IN U30 U50 U70

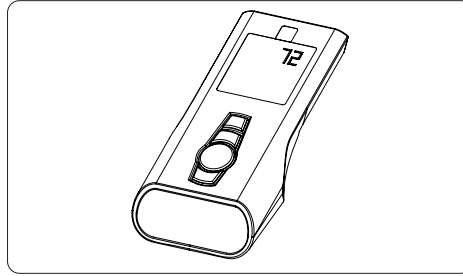

#50-3888 - PF2 WIFI READY TRANSMITTER
PART USED IN U30 U50 U70

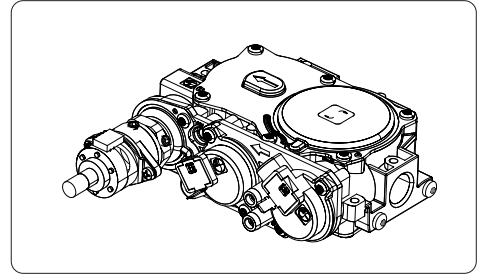

#50-2682 - SIT 885 VALVE W/ STEPPER MOTOR
(NG)
PART USED IN U30 U50 U70

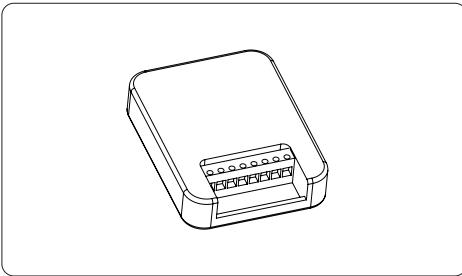

#50-3889 - LED WIFI CONTROLLER (OPTION)
PART USED IN U30 U50 U70

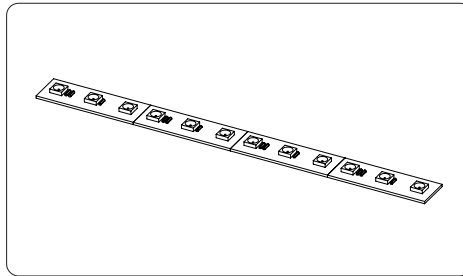

#50-3891 - LED LIGHTING STRIP (OPTION)
PART USED IN U30 U50 U70

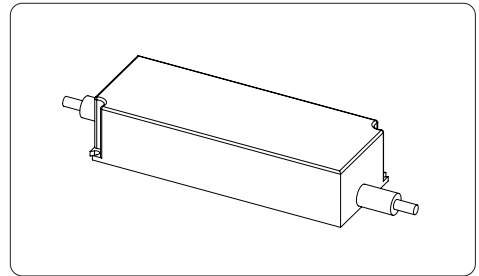

#50-3890 - LED DRIVER (OPTION)
PART USED IN U30 U50 U70

Gaskets	Part numbers
U-Series Firebox Glass gasket (20ft)	#50-3896
U-Series Silicone Glass Gasket (4ft)	#50-3897
U30 Relief Gasket (2 pcs)	#50-3910
U50 & U70 Relief Gasket (2 pcs)	#50-3921

Wire Harnesses	Part Numbers
ProFlame 2 IFC Wire Harness	#50-3030
U-Series On/Off Switch Harness	#50-3893
U50/U70 Fan Wire Harness	#50-3927

<p>“Nothing happens when I turn on the fireplace with the remote.”</p>	<ol style="list-style-type: none"> 1. Move closer to fireplace & try again. (listen for acknowledgement beeps) 2. Check batteries in remote. 3. If Thermostat mode is selected, ensure Thermostat temp is set below current room temperature. 4. Re-sync the remote to the fireplace. 5. Check burner switch is in the on position. 6. Call Your dealer to arrange a service call.
<p>“My Glass has condensation on it”</p>	<ol style="list-style-type: none"> 1. Condensation is a normal occurrence in direct Vented fireplaces. it will evaporate when the unit heats up. 2. To reduce the amount of condensation you see, it is suggested to leave your unit in CPI mode. (Page 8) This leaves the pilot light on for a maximum of 7 days. This keeps your firebox warm and dry thereby reducing the moisture in the firebox that would result in condensation.

Please fill in and retain this information card for your future reference.

Go to www.enviro.com/warranty to fill in your warranty registration card.

NAME OF DEALER:

ADDRESS:

PHONE: _____

NAME OF INSTALLER:

ADDRESS:

PHONE: _____

MODEL: _____

SERIAL NUMBER: _____

DATE OF PURCHASE: _____ (dd/mm/yyyy)

DATE OF INSTALLATION: _____ (dd/mm/yyyy)

NATURAL GAS (NAT) PROPANE(LPG)

INLET GAS PRESSURE: _____ in wc

MAIN BURNER ORIFICE: _____ # DMS

PILOT ORIFICE # _____ **OR** _____ in diam.

INSTALLER'S SIGNATURE:

URBANA LUXURY FIREPLACES

WARRANTY INFORMATION

Sherwood Industries Ltd. ("Sherwood") hereby warrants, subject to the terms and conditions herein set forth, this product against defects in material and workmanship during the specified warranty period starting from the date of original purchase at retail. In the event of a defect of material or workmanship during the specified warranty period, Sherwood reserves the right to make repairs or to assess the replacement of a defective product at Sherwood's factory. The shipping costs are to be paid by the consumer. All warranties by Sherwood are set forth herein and no claim shall be made against Sherwood on any oral warranty or representation.

Conditions

- ☞ A completed warranty registration must be submitted to Sherwood within 90 days of original purchase via the online warranty registration page or via the mail-in warranty registration card provided. Have the installer fill in the installation data sheet in the back of the manual for warranty and future reference.
- ☞ This warranty applies only to the original owner in the original location from date of install.
- ☞ The unit must have been properly installed by a qualified technician or installer, and must meet all local and national building code requirements.
- ☞ The warranty does not cover removal and re-installation costs.
- ☞ Sherwood Industries Ltd. reserves the right to make changes without notice.
- ☞ Sherwood Industries Ltd. and its employees or representatives will not assume any damages, either directly or indirectly caused by improper usage, operation, installation, servicing or maintenance of this appliance.
- ☞ A proof of original purchase must be provided by you or the dealer including serial number.

Exclusions

An expanded list of exclusions is available at www.urbanafireplaces.com/warranty.html

This warranty does not cover:

- ☞ Damage as a result of improper usage or abuse.
- ☞ Damage caused from over-firing due to incorrect setup or tampering.
- ☞ Damage caused by incorrect installation.

To the Dealer

- ☞ Provide name, address and telephone number of purchaser and date of purchase.
- ☞ Provide date of purchase. Name of installer and dealer. Serial number of the appliance. Nature of complaint, defects or malfunction, description and part # of any parts replaced.
- ☞ Pictures or return of damaged or defective product may be required.

To the Distributor

- ☞ Sign and verify that work and information are correct.

Sherwood Industries Ltd.

6782 Oldfield Road, Victoria, BC . Canada V8M 2A3
Online warranty registration: www.urbanafireplaces.com/warranty/

Category	One Year	Two Year	Limited Lifetime (7yr)
Parts ¹ (unit serial number required)		✓	
Firebox Liner Panels ²		✓	
Firebox			✓
Burner			✓
Ceramic Logs ³			✓
Ceramic Glass ⁴	✓		
Door Assembly			✓
Exterior Panels (excluding finish) ⁵			Up to 5 years
Electrical Components		✓	
Labour	✓		

¹ Whereas warranty has expired, replacement parts will be warranted for 90 days from part purchase date. Labour not included. Unit serial # required.

² Excluding damage to the finish caused by improper setup of the appliance, or color changes.

³ Log set and panels excludes wear and tear or breakage caused by cleaning or service.

⁴ Glass is covered for thermal breakage. Photos of box, inside of door, and unit serial # must be supplied for breakage due to shipping.

⁵ Exterior Surface finishing covers plating, enamel or paint and excludes colour changes, chipping, and fingerprints. Travel costs not included.